



Brushless Servo Motors

Installation and Operating Manual

October 2021

— MN1240_October 2021

Any trademarks used in this manual are the property of their respective owners.

Note: Baldor Electric Company, became ABB Motors and Mechanical, Inc. on March 1, 2018. Nameplates, Declaration of Conformity and other collateral material may contain the company name of Baldor Electric Company and the brand names of Baldor-Dodge and Baldor-Reliance as well as the company name of ABB until such time as all materials have been updated to reflect our new corporate identity of ABB.

Table of Contents

Section 1	
General Information	1-1
Overview	1-1
Safety Notice	1-1
Section 2	
Installation	2-1
Overview	2-1
Location	2-1
Alignment	2-1
Receiving	2-2
Storage	2-2
Unpacking	2-2
Handling	2-2
Repairs	2-2
Prevent Electrical Noise	2-2
Shaft Loads	2-3
Life Determination	2-5
Speed and Torque	2-7
Holding Brake	2-7
Electrical Connections	2-8
Motor Lead Termination	2-9
Strain Relief (Mounted at Terminal Box)	2-9
Feedback Termination	2-9
Feedback Devices	2-13
Brushless Servo Motor Identification	2-15

Section 1

General Information

Overview

This manual contains general procedures that apply to ABB Motor products. Be sure to read and understand the Safety Notice statements in this manual. For your protection, do not install, operate or attempt to perform maintenance procedures until you understand the Warning and Caution statements.

A Warning statement indicates a possible unsafe condition that can cause harm to personnel.

A Caution statement indicates a condition that can cause damage to equipment.

Important: This instruction manual is not intended to include a comprehensive listing of all details for all procedures required for installation, operation and maintenance. This manual describes general guidelines that apply to most of the motor products shipped by ABB. If you have a question about a procedure or are uncertain about any detail, **Do Not Proceed**.

Please contact your distributor for more information for clarification.

Before you install, operate or perform maintenance, become familiar with the following:

- NEMA Publication ICS16, Motion/Position Control Motors; Controls; and Feedback Devices.
- The National Electrical Code
- Local codes and Practices

Safety Notice:

This equipment contains high voltage! Electrical shock can cause serious or fatal injury. Only qualified personnel should attempt installation, operation and maintenance of electrical equipment. Be sure that you are completely familiar with NEMA publications ICS16 and MG-2, safety standards for construction and guide for selection, installation and use of electric motors and generators, the National Electrical Code and local codes and practices. Unsafe installation or use can cause conditions that lead to serious or fatal injury. Only qualified personnel should attempt the installation, operation and maintenance of this equipment.

WARNING: Do not use these motors in the presence of flammable or combustible vapors or dust. These motors are not designed for atmospheric conditions that require explosion proof construction.

WARNING: Do not touch electrical connections before you first ensure that power has been disconnected. Electrical shock can cause serious or fatal injury. Only qualified personnel should attempt the installation, operation and maintenance of this equipment.

WARNING: Be sure the system is properly grounded before applying power. Do not apply power before you ensure that all grounding instructions have been followed. Electrical shock can cause serious or fatal injury. National Electrical Code and Local codes must be carefully followed.

WARNING: Avoid extended exposure to machinery with high noise levels. Be sure to wear ear protective devices to reduce harmful effects to your hearing.

WARNING: The holding brake alone does not guaranty personnel safety. Use structural measures such as protective fences or a second brake to secure personnel safety.

WARNING: This equipment may be connected to other machinery that has rotating parts or parts that are driven by this equipment. Improper use can cause serious or fatal injury. Only qualified personnel should attempt to install, operate, or maintain this equipment.

Safety Notice Continued

- WARNING:** Do not by-pass or disable protective devices or safety guards. Safety features are designed to prevent damage to personnel or equipment. These devices can only provide protection if they remain operative.
- WARNING:** Avoid the use of automatic reset devices if the automatic restarting of equipment can be hazardous to personnel or equipment.
- WARNING:** Be sure the load is properly coupled to the motor shaft before applying power. The shaft key must be fully captive by the load device. Improper coupling can cause harm to personnel or equipment if the load decouples from the shaft during operation.
- WARNING:** Use proper care and procedures that are safe during handling, lifting, installing, operating and maintaining operations. Improper methods may cause muscle strain or other harm.
- WARNING:** Servo permanent magnet motors can induce voltage and current in the motor leads by rotating the motor shaft. Electrical shock can cause serious or fatal injury. Therefore, do not couple the load to the motor shaft until all motor connections have been made. During any maintenance inspections, be sure the motor shaft will not rotate.
- WARNING:** Before performing any motor maintenance procedure, be sure that the equipment connected to the motor shaft cannot cause shaft rotation. If the load can cause shaft rotation, disconnect the load from the motor shaft before maintenance is performed. Unexpected mechanical rotation of the motor parts can cause injury or motor damage.
- WARNING:** Disconnect all electrical power from the motor windings and accessory devices before disassembly of the motor. Electrical shock can cause serious or fatal injury.
- WARNING:** Ensure all electrical connections are securely made. High voltage may be present and high motor speeds may result from a broken connection.
- WARNING:** Pacemaker Danger – Magnetic and electromagnetic fields in the vicinity of current carrying conductors and permanent magnet motors can result in a serious health hazard to persons with cardiac pacemakers, metal implants and hearing aids.
- WARNING:** Dangerous movements can occur when a motor is improperly connected or a fault occurs. Be careful during start-up, troubleshooting and maintenance procedures to avoid injury.
- WARNING:** Severe burn is possible. The motor winding can reach 155 degrees C during operation. Do not touch motor without protective clothing or allow sufficient time for motor to cool to avoid burns.
- Caution:** To prevent premature equipment failure or damage, only qualified maintenance personnel should perform maintenance.
- Caution:** Do not lift the motor and its driven load by the motor lifting hardware. The motor lifting hardware is adequate for lifting only the motor. Disconnect the load from the motor shaft before moving the motor.
- Caution:** To prevent equipment damage, be sure that the control is fused for the maximum motor rated amps listed on the rating plate.
- Caution:** If a HI POT test (High Potential Insulation test) must be performed, follow the precautions and procedure in NEMA MG-1 and MG-2 standards to avoid equipment damage.
- Caution:** Do not perform dielectric withstand tests on any feedback device or motor control as damage may result.
- Caution:** Motor housings get very hot during normal operation. Do not touch the motor after use until it has had sufficient time to cool. Severe burns may result from touching the motor after use.
- Caution:** Do not use the holding brake to stop motion. This will cause premature brake wear and failure. The brakes are not designed to stop a rotating load. The servo drive inputs should always be used to stop motor shaft rotation.
- Caution:** The AC servo motor is not intended to be connected directly to the AC mains. Do not connect AC Mains directly to BSM AC Servo Motors.

If you have any questions or are uncertain about any statement or procedure, or if you require additional information please contact your ABB representative or an Authorized ABB Service Center.

Section 2

Installation

Overview

Installation should conform to the National Electrical Code as well as local codes and practices. When other devices are coupled to the motor shaft, be sure to install protective devices to prevent accidents. Some protective devices include, coupling, belt guard, chain guard, shaft covers etc. These protect against accidental contact with moving parts. Machinery that is accessible to personnel should provide further protection in the form of guard rails, screening, warning signs etc.

Location

The motor should be installed in an area that is protected from direct sunlight, corrosives, harmful gases or liquids, dust, metallic particles, and vibration. Exposure to these can reduce the operating life and degrade performance. Be sure to allow clearance for ventilation and access for cleaning, repair, service and inspections. Ventilation is extremely important. Be sure the area for ventilation is not obstructed. Obstructions will limit the free passage of air. Motors get warm and the heat must be dissipated to prevent damage. These motors are not designed for atmospheric conditions that require explosion proof operation. They must NOT be used in the presence of flammable or combustible vapors or dust. The motor must be securely installed to a rigid foundation or mounting surface to minimize vibration and maintain alignment between the motor and shaft load. Failure to provide a proper mounting surface may cause vibration, misalignment and bearing damage. For mounting dimensions, refer to http://www.baldor.com/products/servo_motors.asp and provide adequate clearance.

Alignment

Accurate alignment of the motor with the driven equipment is extremely important.

1. Direct Coupling

For direct drive, use flexible couplings if possible. Consult the drive or equipment manufacturer for more information. Mechanical vibration and roughness during operation may indicate poor alignment. Use dial indicators to check alignment. The space between coupling hubs should be maintained as recommended by the coupling manufacturer.

2. End-Play Adjustment

The axial position of the motor frame with respect to its load is also extremely important. The motor bearings are not designed for excessive external axial thrust loads. Improper adjustment will cause failure.

Figure 2-1 Mounting Orientation

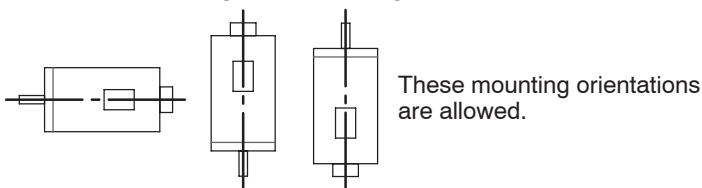

Receiving

Each ABB Motor is thoroughly tested at the factory and carefully packaged for shipment. When you receive your motor, there are several things you should do immediately.

1. Observe the condition of the shipping container and report any damage immediately to the commercial carrier that delivered your motor.
2. Verify that the part number of the motor you received is the same as the part number listed on your purchase order.

Storage

If the motor is not put into service immediately, the motor must be stored in a clean, dry and warm location. If the parts are not put into service immediately, store them in a clean, dry and warm location. The motor must be protected from moisture and condensation. Storage area should be a dust free environment, maintained -25 degC to $+85\text{ degC}$ and less than 90% relative humidity non-condensing.

Unpacking

Each ABB motor is packaged for ease of handling and to prevent entry of contaminants.

1. To avoid condensation inside the motor, do not unpack until the motor has reached room temperature. (Room temperature is the temperature of the room in which it will be installed). The packing provides insulation from temperature changes during transportation.
2. When the motor has reached room temperature, remove all protective wrapping material from the motor.

Handling

Use proper care and procedures that are safe during handling, lifting, installing, operating and maintenance operations. Improper methods may cause muscle strain or other harm.

Repairs

ABB will not share any responsibility for damage caused by customer attempt to repair or modify a motor. Consult ABB for any service.

Prevent Electrical Noise

Electro-Magnetic-Interference (EMI), commonly called “electrical noise” may adversely affect motor performance by introducing stray signals. Effective techniques to reduce or prevent EMI include AC power filters, cable shielding, separating signal wires from power wires and good grounding techniques.

Effective AC power filtering can be achieved by using properly installed “Isolated AC Power Transformers” or “AC Line Filters”. Other techniques are:

- Install motor cables and signal wires in separate conduits.
- Do not route motor cables and signal wires in parallel. Separate cables by at least 1 foot for every 30 feet of run.
- Cross signal and power wires at 90 degree angles to prevent inductive noise coupling.
- Do not route signal wires over the vent openings of the servo drives.
- Ground all equipment using a single point ground system.
- Keep wires as short as possible.
- Ground both ends of the encoder cable and use twisted pair wires.
- Use shielded motor cables to prevent EMI from other equipment.

Shaft Loads

The motors can be damaged by excessive shaft loads. This may shorten the motor's service life. The motor warranty is also voided for excessive shaft load related failures. The maximum allowable radial force ($F_{\text{radial max}}$) depends on the shaft load. It is determined by (distance x force) and the output shaft design (plain shaft or shaft with keyway). When motor shaft has both a radial load and an axial load, axial load rating = 44% of radial load rating listed.

Figure 2-2 Radial Load Capacity

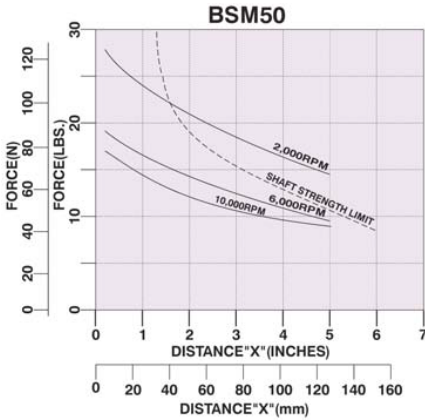

Notes:

- 1) Solid lines are based on $L_{10} = 20,000$ hours.
- 2) Dashed lines are based on 10^4 load peaks at 110% of rated torque.

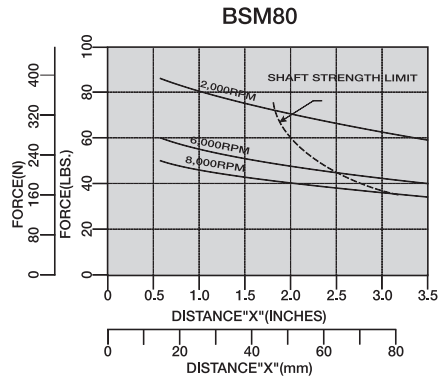
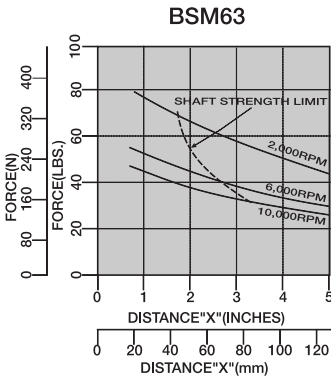
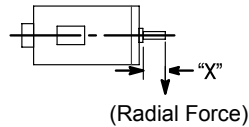
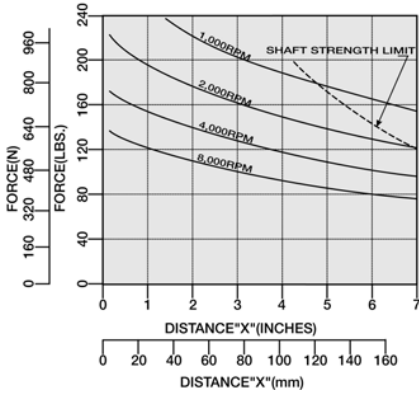
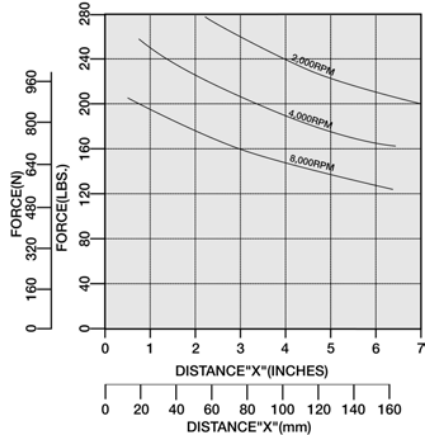

Figure 2-3 Radial Load Capacity Continued

BSM90



BSM100



BSM132

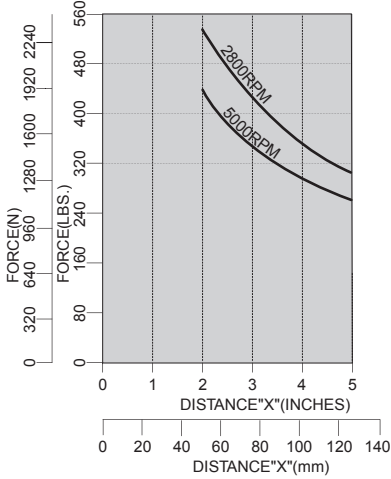

BRUSHLESS SERVO MOTORS
THRUST LOAD CAPACITIES

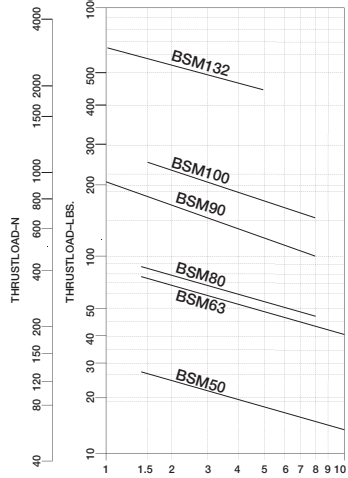

Life Determination

How Life is Determined

A life estimate is a calculated, statistical expectancy and is defined as the length of time, or the number of revolutions, until fatigue develops. This life depends on many different factors such as loading, speed, lubrication, operating temperature, contamination, plus other environmental factors. It's impossible to predict precisely. Statistical calculation estimates are based upon L_{10} life. This is the life that 90 percent of a group, of apparently identical parts, will reach or exceed. Typical bearing radial load capacity curves presented in the literature are based upon bearing L_{10} life of 20,000 hours.

Using the Curves

First determine your load (or force), location (or distance) from the bearing the load will be applied, and speed (or RPM). Second, plot these points on the curve. For example, using the BSM80 (Figure 2-4) a force of 80 lbs (352 N), applied 1 inch (25mm) from the bearing, with a motor speed of 2,000 RPM, would relate to a bearing L_{10} life estimate of 20,000 hours.

Figure 2-4

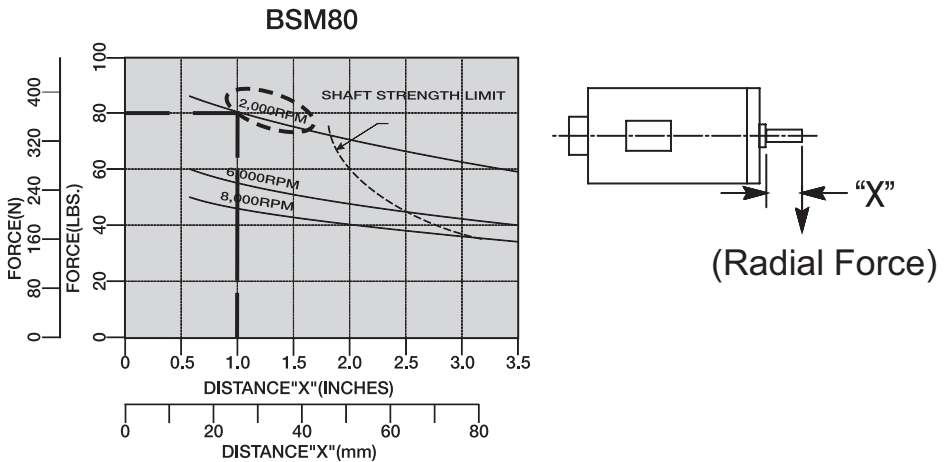

Operating 24 hours / day, results in approximately 8500 hours per year. This would provide a L_{10} life estimate of: (20,000 hours) / (8500 hours/yr)=2.35yrs.

If Plotted Point Does Not Match your RPM

Many times the point plotted (force and distance), is not specifically on your applications speed curve, so an estimate for life is calculated as follows:

$$L_{10} = \left(\frac{16667}{S} \right) \times \left(\frac{C}{F} \right)^3$$

Where: $L_{10} = 20,000$ hours
 $S = \text{RPM}$

$C = \text{capacity of system}$
 $F = \text{Force or Load (lb)}$

Example: Provide an estimate L_{10} life for a BSM90 motor with a radial load or force of 130 lbs (570 N) located 3" (76mm) from the bearing. Operating speed is 1000 RPM.

1. Determine the systems capacity – at the distance for our application. To do this, refer to Figure 2-5 and read information from the curve:
 - a. Locate our distance (3") on the X axis.
 - b. Pick a speed (8,000 RPM) and locate the intersect with the 3".
 - c. Read the force (100 lbs) on the Y axis.

Figure 2-5 BSM90 Load Capacity Curves

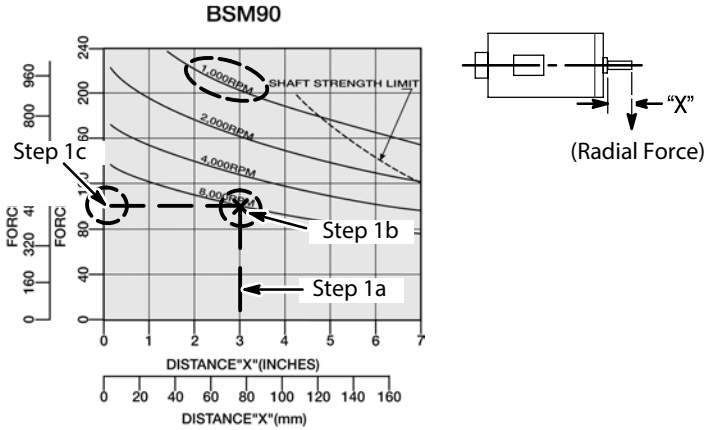

- d. Next, insert these numbers into equation (1) above and solve for capacity "C" (round off for clarity):

$$L_{10} = \left(\frac{16667}{S}\right) \times \left(\frac{C}{F}\right)^3 = \left(\frac{16 \times 10^3}{8 \times 10^3}\right) \times \left(\frac{C}{100}\right)^3$$

$$20,000 = \left(\frac{16667}{8000}\right) \times \left(\frac{C}{100}\right)^3$$

$$C = 2125$$

2. Now that capacity is known, it is possible to estimate L_{10} with the applications load of 130 lbs (570 N) and 1000 RPM.

$$L_{10} = \left(\frac{16667}{S}\right) \times \left(\frac{C}{F}\right)^3 = \left(\frac{16 \times 10^3}{1 \times 10^3}\right) \times \left(\frac{2125}{130}\right)^3 = 72,795 \text{ hours}$$

This relates to 72,795 hours / 8500 hours/yr = 8.56 years.

Conclusion

Life is a statistical calculation based upon 90 percent of identical parts reaching or exceeding an estimate. It depends on many different factors and is impossible to predict precisely, however calculations provide a guideline.

Motor Poles

BSM50/63/80 Series motors are 4 pole (2 pole pair)

BSM 90/100/132 Series motors are 8 pole (4 pole pair)

Speed and Torque

The speed–torque curves for a motor show the safe operating area, speed limit area and intermittent operating area. These curves are used to determine the maximum useable speeds with known torque requirements.

If operating within the continuous area, the motor's thermal limit will not be exceeded. If operated within the intermittent area (extended operation in this area will cause the motor to overheat), the operating time in this area must be limited to prevent overheating.

Brushless servo motors are rated at an ambient of 25 degrees C and a temperature rise of 130 degrees C. For operation at 40 degrees C derate by 8%.

WARNING: Severe burn is possible. The motor winding can reach 155 degrees C during operation. Do not touch motor without protective clothing or allow sufficient time for motor to cool to avoid burns.

Figure 2-6 Typical Speed–Torque Curve

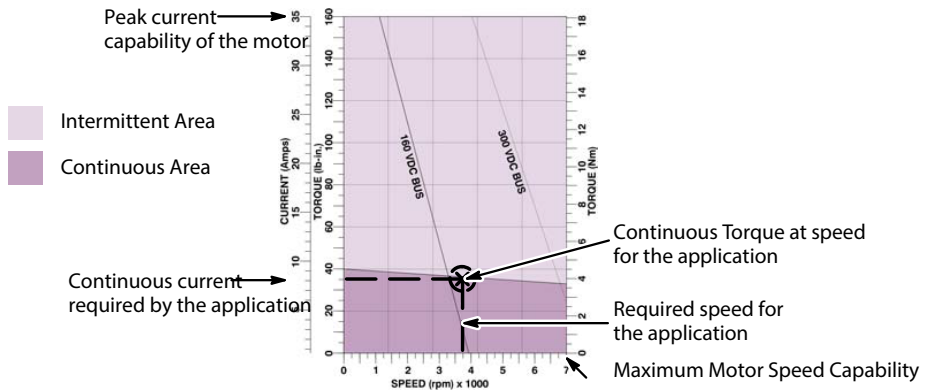

Holding Brake

Holding brakes are offered as options for servo motors. These brakes are designed to hold the motor shaft at 0 RPM (to rated brake holding torque). The purpose of the holding brake is to hold the servo axis when power to the machine is turned off. The holding brake uses the “electric release” principle. Applying 24VDC to the brake causes the brake to release and lets the motor shaft rotate. Loss of power causes the brake to hold the motor shaft. The machine controller controls the holding brake. This ensures correct On and Off switching sequence.

WARNING: The holding brake alone does not guarantee personnel safety. Use structural measures such as protective fences or a second brake to secure personnel safety.

Caution: Do not use the holding brake to stop motion. This will cause premature brake wear and failure. The brakes are not designed to stop a rotating load. The servo drive inputs should always be used to stop motor shaft rotation.

Table 2-1 Brake Specifications

Brake data for BSM and SSBSM							
Motor Code	Brake Holding Torque Nm (lb-in)	Watts	Brake voltage (Vdc)	Brake current (amps)	Set Time (ms)	Release Time (ms)	Brake inertia Kg-cm ² (lb-in-s ²)
BSM50N	1.1 (10)	12.4	24	0.52	3	20	0.019 (0.000017)
BSM63N	2 (18)	17	24	0.71	16	43	0.018 (0.000016)
BSM80	4.5 (40)	17	24	0.71	9	48	0.125 (0.000111)
BSM90	15.8 (140)	22	24	0.92	14	110	0.181 (0.00016)
BSM100	39.5 (350)	19	24	0.79	22	195	0.723 (0.00064)
BSM25C	1.7 (15)	9.6	24	0.4	16	27	0.034 (0.00003)
BSM33C	15.8 (140)	21.6	24	0.9	14	110	0.181 (0.00016)
BSM132C	101.7 (900)	76	24	3.17	129	163	17.277 (0.01529)

Note: All standard brakes used on BSM motors are 24 Vdc. The application needs to provide this voltage to release the brake. The brake is a safety brake only and not intended to be used to decelerate loads. Contact ABB for details. Detailed engineering drawings are available upon request.

Electrical Connections

Overview Figure 2-7 shows typical connections to a control. Note all wiring should be 600volts.

Figure 2-7 Typical Connections to Motor Control

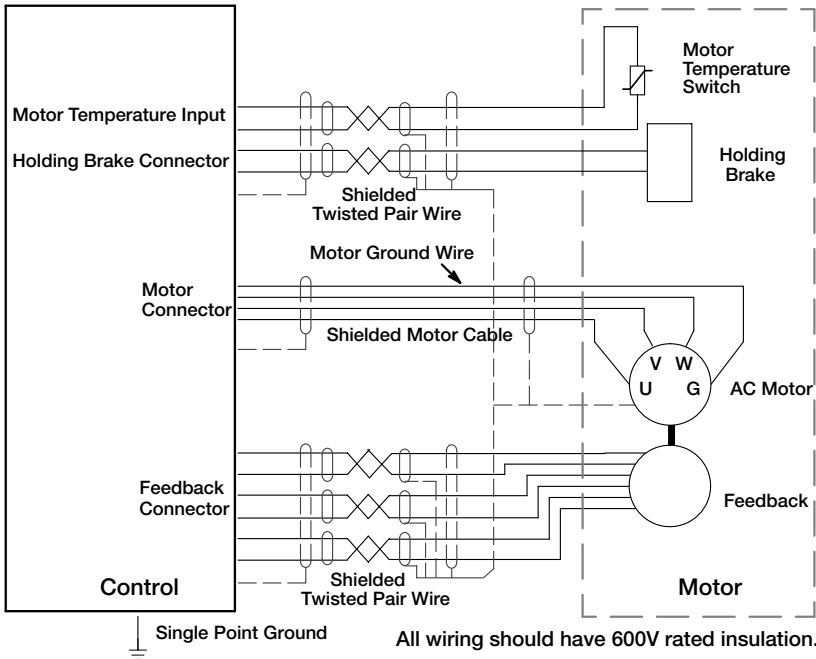

Motor Lead Termination

Motor leads are normally terminated using a Connector or Terminal Box (see Figure 2-8) or Flying Leads. When no termination is provided and the motor leads just exit the motor housing, this is called “Flying Leads”. For flying leads, refer to the motor packing list to determine the lead configuration.

Figure 2-8 Motor Termination

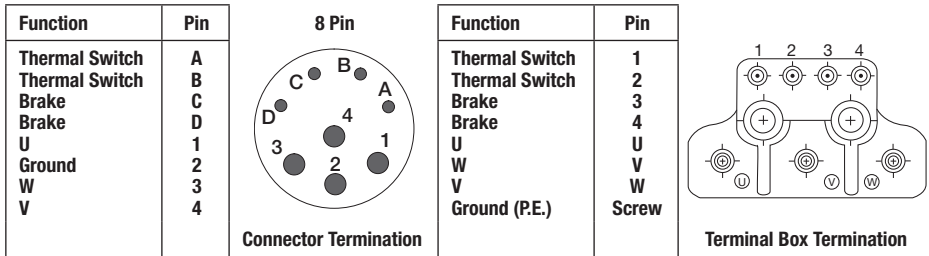

Strain Relief (Mounted at Terminal Box)

The motor cable is terminated at the Terminal Box using a Shielded Strain Relief Connector. Figure 2-9 shows the components.

1. Strip the outer shield from the cable to expose the conductors and shield.
2. Slip the Strain Relief components onto the cable in the order shown.
3. Fold the Shield wires over the end of the Contact Carrier.
4. Slide the Threaded Adapter onto the Contact Carrier until the Carrier is completely inserted into the Adapter.
5. Slide the Gasket into the Contact Carrier.
6. Slide the Adapter Cover onto the Threaded Adapter and Tighten. As it is tightened, it compresses the Gasket against the Cable to form the strain relief and securely hold the cable.
7. The assembly can be inserted into the Terminal Box and secured.

Figure 2-9 Motor Cable Strain Relief Assembly

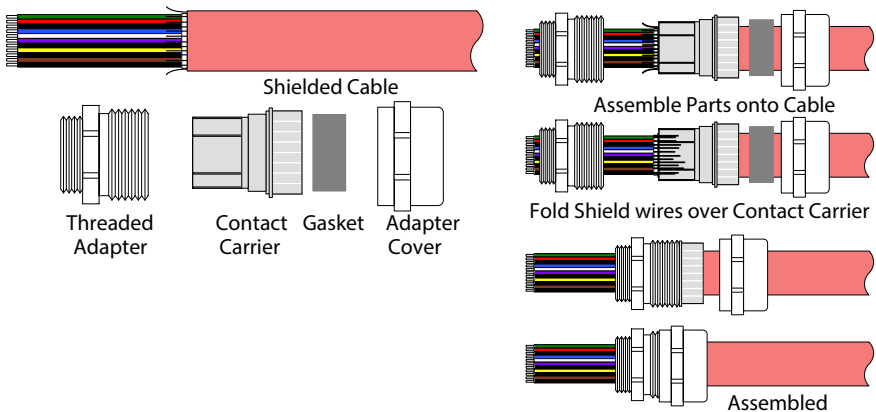

Feedback Termination

Connections for Feedback cables are different for each type of feedback device. Standard devices are: Resolver, Halls (Hall Effect), Incremental Encoder with Halls, and Absolute Encoders including SSI, EnDat, BiSS, and Hiperface.

Custom feedback devices are also available. Request a drawing of your feedback device to determine the pin-out and/or wire color codes.

Figure 2-10 Typical Connections to Feedback Termination

**Motor-Resolver
BSMxxx-xxxxA**

Terminal block

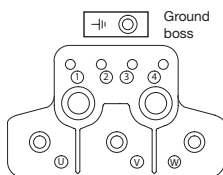

Power connections
BSM 90/100

Post	Function
1	Thermal switch
2	Thermal switch
3	Brake (optional)
4	Brake (optional)
U1	Motor lead U
V2	Motor lead V
W3	Motor lead W
Screw	Ground

**Motor-Incremental encoder
BSMxxx-xxxxF or E**

Terminal block

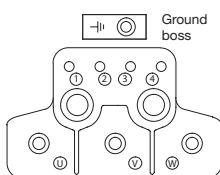

Power connections
BSM 90/100

Post	Function
1	Thermal switch
2	Thermal switch
3	Brake (optional)
4	Brake (optional)
U1	Motor lead U
V2	Motor lead V
W3	Motor lead W
Screw	Ground

Standard and rotatable
connectors

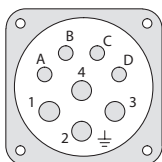

Power connections
BSM 50/63/80 and SSBSM

Post	Function
A	Thermal switch
B	Thermal switch
C	Brake (optional)
D	Brake (optional)
1	Motor lead U
2	Ground
3	Motor lead W
4	Motor lead V

Standard motor
connector

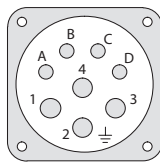

Power connections
BSM 50/63/80 and SSBSM

Post	Function
A	Thermal switch
B	Thermal switch
C	Brake (optional)
D	Brake (optional)
1	Motor lead U
2	Ground
3	Motor lead W
4	Motor lead V

Standard and rotatable
connectors

12 Pin

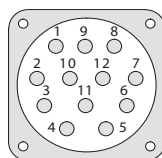

Resolver connections
BSM and SSBSM

Post	Function
1	REF HI R1
2	REF LO R2
3	COS+ S1
4	COS- S3
5	SINE- S4
6	SINE+ S2
7-12	No connection

Standard encoder
connector

16 Pin

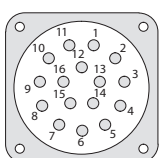

Encoder connections
BSM and SSBSM

Post	Function
1	DC + 5V
2	Ground
3	Channel A
4	Channel <u>A</u>
5	Channel B
6	Channel <u>B</u>
7	Channel Z
8	Channel <u>Z</u>
9	Open
10	Channel U
11	Channel <u>U</u>
12	Channel V
13	Channel <u>V</u>
14	Channel W
15	Channel <u>W</u>
16	No connection

Note: For BSM 50/63/80 (and option on BSM90/100), the standard and rotatable power connector is rated at 28 amps. BSM brakes are not polarity sensitive.

Figure 2-10 Typical Connections to Feedback Termination

**Motor-BiSS
BSMxxx-xxxxB or B2**

Terminal block

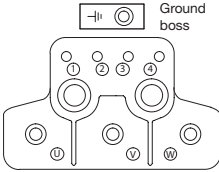

Power connections
BSM 90/100

Post	Function
1	Thermal switch
2	Thermal switch
3	Brake (optional)
4	Brake (optional)
U1	Motor lead U
V2	Motor lead V
W3	Motor lead W
Screw	Ground

**Motor-EnDat
BSMxxx-xxxxD2 or D**

Terminal block

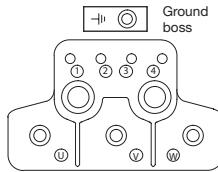

Power connections
BSM 90/100

Post	Function
1	Thermal switch
2	Thermal switch
3	Brake (optional)
4	Brake (optional)
U1	Motor lead U
V2	Motor lead V
W3	Motor lead W
Screw	Ground

Standard and rotatable
connectors

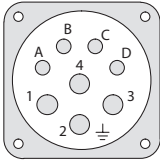

Power connections
BSM 50/63/80 and SSBSM

Post	Function
A	Thermal switch
B	Thermal switch
C	Brake (optional)
D	Brake (optional)
1	Motor lead U
2	Ground
3	Motor lead W
4	Motor lead V

Standard motor
connector

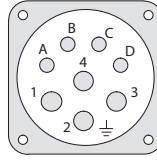

Power connections
BSM 50/63/80 and SSBSM

Post	Function
A	Thermal switch
B	Thermal switch
C	Brake (optional)
D	Brake (optional)
1	Motor lead U
2	Ground
3	Motor lead W
4	Motor lead V

Standard BiSS
connector

12 Pin

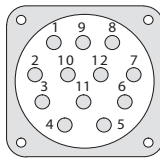

BiSS connections
BSM and SSBSM

8Post	Function
1	DATA-
2	A+ (SIN+)
3	OV sensor
4	B+ (COS+)
5	Clock-
6	-
7	Clock+
8	B- (COS-)
9	5V & up sense
10	OV DGND
11	A- (SIN-)
12	DATA+

Standard EnDat
connector

12 Pin

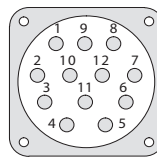

EnDat connections
BSM and SSBSM

Post	Function
1	DATA-
2	SIN A+
3	OV sensor
4	COS B+
5	Clock-
6	5V sensor
7	Clock+
8	COS B-
9	+5V
10	DGND
11	SIN A-
12	DATA+

Note For BSM 50/63/80 (and option on BSM90/100), the standard and rotatable power connector is rated at 28 amps.
BSM brakes are not polarity sensitive.

Figure 2-10 Typical Connections to Feedback Termination

Motor-SSi
BSMxxx-xxxxS1 or S2

Terminal block

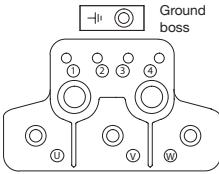

Power connections
BSM 90/100

Post	Function
1	Thermal switch
2	Thermal switch
3	Brake (optional)
4	Brake (optional)
U1	Motor lead U
V2	Motor lead V
W3	Motor lead W
Screw	Ground

Standard motor connector

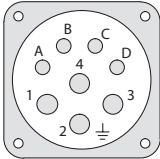

Power connections
BSM 50/63/80 and SSBSM

Post	Function
A	Thermal switch
B	Thermal switch
C	Brake (optional)
D	Brake (optional)
1	Motor lead U
2	Ground
3	Motor lead W
4	Motor lead V

Standard SSI connector
12 Pin

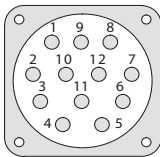

SSI connections
BSM and SSBSM

Post	Function
1	+Vs (5Vdc)
2	OV
3	SSI clock
4	SSI clock
5	SSI DATA
6	SSI DATA
7	-
8	-
9	Connected to pin 1
10	-
11	-
12	-

Motor-Hiperface
BSMxxx-xxxxD3 or D4

Terminal block

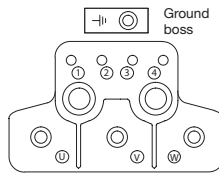

Power connections
BSM 90/100

Post	Function
1	Thermal switch
2	Thermal switch
3	Brake (optional)
4	Brake (optional)
U1	Motor lead U
V2	Motor lead V
W3	Motor lead W
Screw	Ground

Standard motor connector

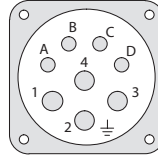

Power connections
BSM 50/63/80 and SSBSM

Post	Function
A	Thermal switch
B	Thermal switch
C	Brake (optional)
D	Brake (optional)
1	Motor lead U
2	Ground
3	Motor lead W
4	Motor lead V

Standard hiperface connector
12 Pin

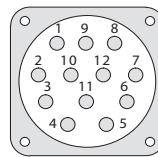

Hyperface connections
BSM and SSBSM

Post	Function
1	DATA-
2	+SIN
3	Open
4	+COS
5	OPEN
6	OPEN
7	OPEN
8	REF COS
9	US 7-12V
10	GND
11	REF SIN
12	DATA+

Note For BSM 50/63/80 (and option on BSM90/100), the standard and rotatable power connector is rated at 28 amps.
BSM brakes are not polarity sensitive.

Feedback Devices

Resolver

Common feedback devices for ABB BSM servo motors include Resolver, Incremental Encoder, and Absolute Encoders. Custom feedback devices are also available. Contact ABB for more information.

Figure 2-10 Typical Resolver Feedback Device

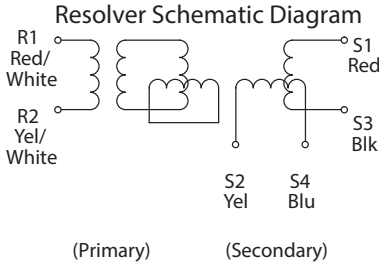

Resolver Specification

Power Source	AC 10Vrms 4.5kHz
Primary Element	Rotor
Electrical Error	±7%
Transformation Ratio	0.5 ±10%
Phase Shift	±8° nominal
Accuracy Spread	12 ARC minutes
Input Impedance	ZRO 90 + j180 Ω nominal
Output Impedance	ZSO 220 + j350 Ω @ 0° (S1-S3)
	210 + j300 Ω @ 0° (S1-S3)
DC Resistance	Rotor 46 Ω REF
	Stator 120 Ω REF
Dielectric Strength	AC 500 volts, 1 minute 60/50 Hz
Insulation Resistance	100M Ω Minimum DC 500Volts
Weight	0.18kg Maximum
Maximum Operating Speed	10,000 RPM
Operating Temperature Range	-55° C to +150° C

L2=Motor lead L2 (V)
L3=Motor lead L3 (W)

Waveform 1
8 Pole Motor and
2 Pole Resolver

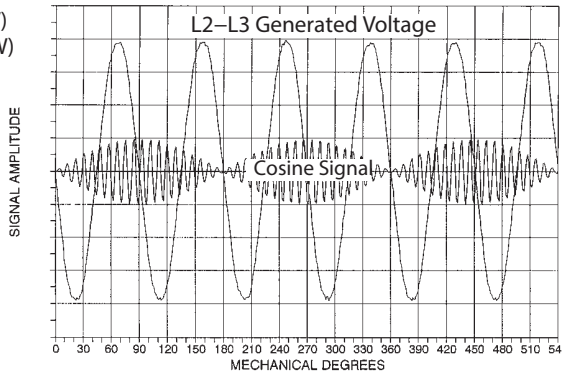

Waveform 2
4 Pole Motor and
2 Pole Resolver

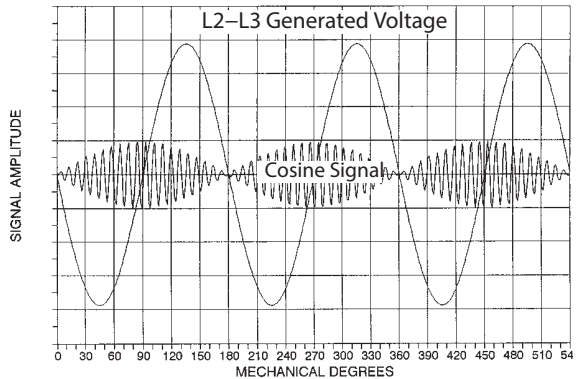

Feedback Devices Continued

Encoder

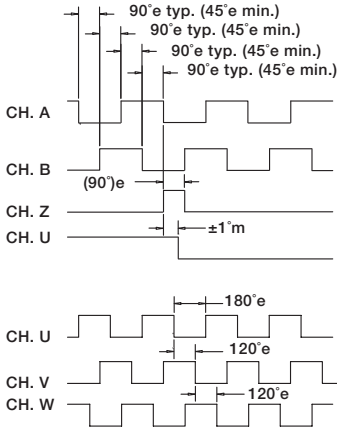

Encoder specifications

Power in	5V
Output	Line driver Incremental 2 channel Index Hall output (4 or 8 pole)
PPR	STD 2500 ppr Contact ABB for other options
Maximum Electrical Frequency	1000/2500 ppr 200 kHz/300kHz
Hall output	BSM/SSBSM 50/63/80 series use 4 pole Hall output. 90/100/132 series use 8 pole Hall output.
Operating temperature range	-20° C to +120° C

BRUSHLESS D.C. COMMUTATION

8 POLE MECH. DEGREES	0	15	30	45	60	75	90	105	120	135	150	165	180
4 POLE MECH. DEGREES	0	30	60	90	120	150	180	210	240	270	300	330	360
ELECTRICAL DEGREES	0	60	120	180	240	300	360	420	480	540	600	660	720

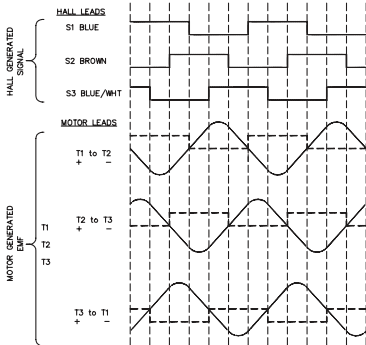

Hall sensor specifications

Power in	3.8-30 Vdc
Output	Hall output (4 or 8 pole)

Brushless Servo Motor Identification



	Frame		Series	Motor size	Winding code
Blank = Std	IEC	NEMA	N	1	50
SS = Stainless steel	50	5N	C	2	75
Note: Not all options are available on all motors. Contact ABB.	63	6N		3	etc.
	80	8N		4	
	90	9N			
	100	10N			
	132				

Motor options

Description	Connections				
	Standard (metric) threaded style	Cables	Optional (inch) quick connect	Flying leads	Rotate-able (metric) threaded
Motor (no shaft seal)	A	E	I	M	R
Motor and brake	B	F	J	N	S
Motor with shaft oil seal	C	G	K	O	T
Motor with brake & shaft oil seal	D	H	L	P	U

Feedback options

- A = Resolver
- B = Absolute encoder - single-turn (BISS)
- B2 = Absolute encoder - multi-turn (BISS)
- D = Absolute encoder - multi-turn (EnDat)
- D2 = Absolute encoder - single-turn (EnDat)
- D3 = Absolute encoder - single-turn (Hiperface)
- D4 = Absolute encoder - multi-turn (Hiperface)
- S1 = Absolute encoder - single-turn (SSI)
- S2 = Absolute encoder - multi-turn (SSI)
- E = Incremental encoder w/ commutation (1000 ppr)
- F = Incremental encoder w/ commutation (2500 ppr)
- H = Halls only
- V = Resolver mounting only

Accessory options

- Blank = No option
- M = No keyway
- N = DIN 42955-R
- O = DIN 42955-R & no keyway
- P = Optional motor connector on BSM 90/100
(Note: This option available only if current less than 28 amps)
- X = Special option (order by spec no. only)
- Z1 = Blower (115 VAC) (not available on all motors)
- Z2 = Blower (230 VAC) (not available on all motors)
- Z3 = Blower (24 Vdc)
- Z4 = Blower (230/460 VAC) for BSM132 only

Note:

1. The standard BSM50/63/80 series includes feedback, two threaded connectors for feedback and motor terminations, square mounting flange.
2. The standard BSM90/100 series includes, one threaded connector for feedback termination, termination of motor lead wires on terminal block, square mounting flange.
3. BSM motors do not have shaft seal as standard. BSM motors are IP54. Motors will meet IP55 with shaft oil seal.
4. SSBSM motors available with IEC mounting and include as standard a shaft seal. SSBSM motors are IP67.
5. The standard BSM50 series has as standard no keyway.
6. Shielded cables and flying leads are one meter long as standard. Flying leads option is composed of individual wires with no armored protection.
7. Order motor power and feedback cable assemblies as separate items.
8. Motors may be used with 115/230/400/460 volt controls. Verify that maximum speed is not exceeded.
9. Rotatable connectors not available on BSM50-series. Standard rotatable on models up to BSM100 available (only if current is less than 28 amps). BSM132 requires a larger connector.
10. Pricing for NEMA versions 5N, 6N, 8N, 9N, and 10N is the same as IEC versions 50, 63, 80, 90, and 100.
11. Contact your local ABB district office for special options.

ABB Motors and Mechanical Inc.

5711 R.S. Boreham, Jr. Street
Fort Smith, AR 72901
Ph: 1.479.646.4711

new.abb.com/motors-generators

Additional information

We reserve the right to make technical changes or modify the contents of this document without prior notice. With regard to purchase orders, the agreed particulars shall prevail. ABB does not accept any responsibility whatsoever for potential errors or possible lack of information in this document.

We reserve all rights in this document and in the subject matter and illustrations contained therein. Any reproduction, disclosure to third parties or utilization of its contents – in whole or in parts – is forbidden without prior written consent of ABB.

© Copyright 2021 ABB. All rights reserved.
Specifications subject to change without notice.

